

Pushbutton Switches

Pushbutton & Multifunction Switches IP40/IP65/IP67

PB78 Series



Characteristics:

- The installation hole's diameter of the series pushbutton: $\Phi 16\text{mm}$.
- Every pushbutton can possess from one to four switch units.
- Use the gold-clad silver contact or silver contact.
- The front shape: Round ($\Phi 18\text{mm}$) Square ($18 \times 18\text{mm}$) Rectangular ($18 \times 24\text{mm}$)
- Many types are available: pilot lamp, pushbutton, illuminated pushbutton, selector switch, and keylock switch.
- IP Protective Degree: IP40, IP65, IP67

Specifications:

Operating Temperature	-25 °C to +55 °C (no freezing)	
Operating Humidity	45 to 85%RH (no condensation)	
Contact material	— silver — silver CdO — gold-clad silver	
Contact pressure	$\approx 0.3\text{N}$ (30g)	
Contact Resistance	$\leq 50\text{m}\Omega$	
Insulation Resistance	$\geq 100\text{M}\Omega$	
Rated insulation voltage	250V, AC/DC	
Dielectric Strength	Between contact and lamp terminals	2000V, AC 50Hz, 1min
	Between terminals of the same pole	1000V, AC 50Hz, 1min
	Between terminals of different pole	2000V, AC 50Hz, 1min
Vibration Resistance	50Hz, Amplitude 1.2mm p-p	
Shock Resistance	$\geq 10\text{g}$ in all three planes	
Soldering Information	Less than 3s at 230 °C	
Life	Mechanical	1,000,000 times
	Electrical	$\geq 50,000$ times
Terminal	Diameter of welded wire: 2x 0.8mm max Area of copper wire: 0.75mm ² max	
Operating force	200gf~500gf (according to the quantity of switch units)	
Operating travel	$\approx 3\text{mm}$ (pushbutton)	
IP Protective Degree	IP40, IP65, IP67	

Switch Ratings :

Thermal Current (I_{th})	5A		
Rated Voltage	24V	125V (110V)	250V (220V)
Direct Current (DC)	1A	0.2A	0.1A
Alternating current (AC)	P.F=1	5 A	3A
	P.F=0.7	3A	2A

Lamp Ratings :

Lamp Type	AC LED Lamp (Standard)			Neon Lamp	
	AC/DC 6V	AC/DC 12V	AC/DC 24V	AC110V	AC220V
Rated Voltage	AC/DC 110V		AC/DC 220V		
Base Color	red, green, yellow, orange, blue, white			red, green	
Life	About 40000 hours			About 20000 hours	

Note : The lamp contains current-limiting resistor inside and doesn't need external connection. DC LED lamp, dual-color LED lamp and other voltages can be customized.

Installation Dimensions

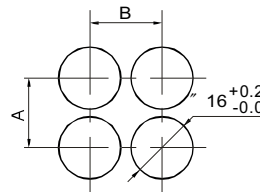

Category	A	B
Round	$\geq 18\text{mm}$	$\geq 18\text{mm}$
Square	$\geq 18\text{mm}$	$\geq 18\text{mm}$
Rectangular	$\geq 18\text{mm}$	$\geq 24\text{mm}$
Mushroom	$\geq 24\text{mm}$	$\geq 24\text{mm}$
Big square	$\geq 24\text{mm}$	$\geq 24\text{mm}$
Big rectangular	$\geq 18\text{mm}$	$\geq 24\text{mm}$

Bottom Preview

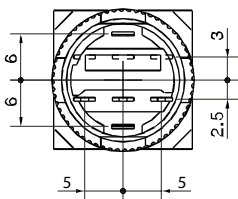

Terminal Arrangement

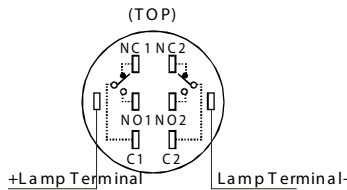

HOW TO ORDER:

PB78

1 FRONT SHAPE:

- Y Round
- F Square
- J Rectangular
- M Mushroom
- DF Big Square
- DJ Big Rectangular

2 CONTACT STRUCTURE:

- 11 1NO 1NC
- 22 2NO 2NC

3 DERIVATIVE CODE:

- blank Momentary
- D Pilot Lamp
- Z Alternate Type
- Y Key Lock Type
- X Selector Type
- T Emergency
- B Buzzer Type

4 POSITION (for selector type & keylock type only):

- 2 Two Positions
- 3 Three Positions

5 ACTUATOR COLOR:

- C Red
- F Green
- E Yellow
- D Orange
- G Blue
- B White
- A Black

7 IP PROTECTIVE DEGREE:

- blank IP40
- IP65 IP65
- IP67 IP67

6 LAMP RATINGS (see table above):

- blank Non-Illuminated
 - free text LED AC 12V (for example)
- The specific rating of the lamp with illuminated button is included in the illuminated unit ratings form.



Pushbutton Switches

Pushbutton & Multifunction Switches IP40/IP65/IP67

PB78 Series

PB78 Pilot Lamp

Product Cutline

Model Number	PB78Y_D_	PB78F_D_	PB78J_D_
Shape			
Remarks	C Red F Green E Yellow D Orange G Blue B White A Black		

PB78 Pushbuttons, Illuminated Pushbuttons

Product Cutline

Note:SPDT single- pole double- throw,DPDT double- pole double Throw.



Shape	Contact	Operating Type	Type Number	Remarks
Round(can be illuminated) 	SPDT	Momentary	PB78Y11_	C Red F Green E Yellow D Orange G Blue B White A Black • Can be used with lamp • The black cover can't be used with the illuminated pushbuttons. • IP40,IP65,IP67 is allowable
		Alternate	PB78Y11Z_	
	DPDT	Momentary	PB78Y22_	
		Alternate	PB78Y22Z_	
Square(can be illuminated) 	SPDT	Momentary	PB78F11_	
		Alternate	PB78F11Z_	
	DPDT	Momentary	PB78F22_	
		Alternate	PB78F22Z_	
Rectangular(ca n be illuminated) 	SPDT	Momentary	PB78J11_	
		Alternate	PB78J11Z_	
	DPDT	Momentary	PB78J22_	
		Alternate	PB78J22Z_	
Mushroom(ca n be illumina ted) 	SPDT	Momentary	PB78M11_	
		Alternate	PB78M11Z_	
	DPDT	Momentary	PB78M22_	
		Alternate	PB78M22Z_	

Pushbutton Switches

Pushbutton & Multifunction Switches IP40/IP65/IP67

PB78 Series

Note: SPDT signal I- pole double- throw, DPDT double- pole double- throw.

Shape	Contact	Operating Type	Type Number	Remarks
Big Square (can be illuminated) 	SPDT	Momentary	PB78DF11_	<ul style="list-style-type: none"> C Red F Green E Yellow D Orange G Blue B White A Black <ul style="list-style-type: none"> • Can be used with lamp • The black cover can't be used with the illuminated pushbuttons. • IP40, IP65, IP67 is allowable
		Alternate	PB78DF11Z_	
	DPDT	Momentary	PB78DF22_	
		Alternate	PB78DF22Z_	
Big Rectangular (can be illuminated) 	SPDT	Momentary	PB78DJ11_	
		Alternate	PB78DJ11Z_	
	DPDT	Momentary	PB78DJ22_	
		Alternate	PB78DJ22Z_	

Shape and Dimensions

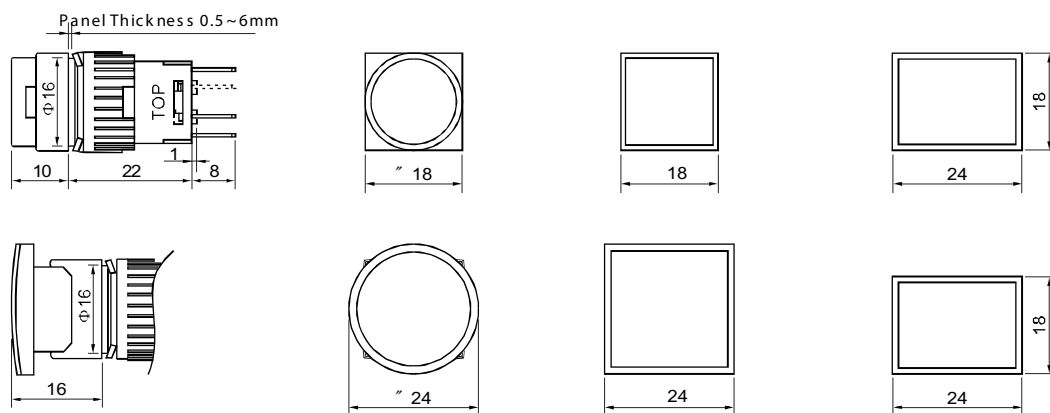









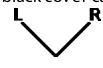

Pushbutton Switches

Pushbutton & Multifunction Switches IP40/IP65/IP67

PB78 Series

PB78 Selector Switches





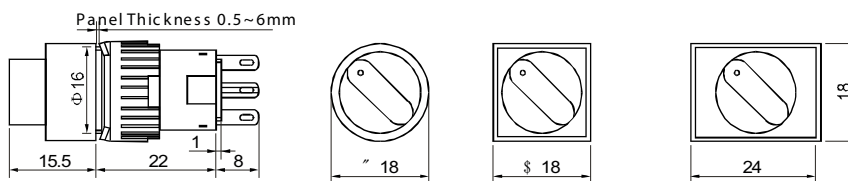

Product Outline

Shape	Position	Contact	Type Number	Remarks
Round(can be illuminated) 	90+ 2 Position 	SPDT	PB78Y11X2_	C Red F Green A Black • Can be used with lamp • IP40 is allowable • The black cover can't be used with the illuminated  90° 2 Position Maintained.
		DPDT	PB78Y22X2_	
	45+ 3 Position 	DPDT	PB78Y22X3_	
Square(can be illuminated) 	90+ 2 Position 	SPDT	PB78F11X2_	
		DPDT	PB78F22X2_	
	45+ 3 Position 	DPDT	PB78F22X3_	
Rectangular(can be illuminated) 	90+ 2 Position 	SPDT	PB78J11X2_	
		DPDT	PB78J22X2_	
	45+ 3 Position 	DPDT	PB78J22X3_	

Shape and Dimensions

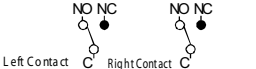

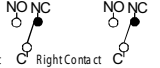
Contact Operation

Position	Contact	Operating Position & Contact Operation		
		Left	Center	Right
90+ 2 Position	1C		/	
	2C			
45+ 3 Position	2C			











Pushbutton Switches

Pushbutton & Multifunction Switches IP40/IP65/IP67

PB78 Series

PB78 Key Lock Switches

Product Cutline

Shape	Position	Key Retained at Position2	Contact	Type	Remarks
	 90+ 2 Position		SP DT	PB78Y11Y2A_	Two keys are supplied. All the keys are same. Protective Degree: IP40,IP65
			DPDT	PB78Y22Y2A_	
			SP DT	PB78Y11Y2B_	
			DPDT	PB78Y22Y2B_	
			SP DT	PB78Y11Y2C_	
			DPDT	PB78Y22Y2C_	
	 45+ 3 Position		DPDT	PB78Y11Y3A_	
			DPDT	PB78Y22Y3B_	
			DPDT	PB78Y11Y3C_	
			DPDT	PB78Y22Y3D_	
			DPDT	PB78Y11Y3E_	
			DPDT	PB78Y22Y3G_	
			DPDT	PB78Y22Y3H_	
			DPDT	PB78Y22Y3H_	
	 90+ 2 Position		SP DT	PB78F11Y2A_	
			DPDT	PB78F22Y2A_	
			SP DT	PB78F11Y2B_	
			DPDT	PB78F22Y2B_	
			SP DT	PB78F11Y2C_	
			DPDT	PB78F22Y2C_	
	 45+ 3 Position		DPDT	PB78F11Y3A_	
			DPDT	PB78F22Y3B_	
			DPDT	PB78F11Y3C_	
			DPDT	PB78F22Y3D_	
			DPDT	PB78F11Y3E_	
			DPDT	PB78F22Y3G_	
			DPDT	PB78F22Y3H_	
			DPDT	PB78F22Y3H_	
	 90, 2 Position		SP DT	PB78J11Y2A_	
			DPDT	PB78J22Y2A_	
			SP DT	PB78J11Y2B_	
			DPDT	PB78J22Y2B_	
			SP DT	PB78J11Y2C_	
			DPDT	PB78J22Y2C_	
	 45, 3 Position		DPDT	PB78J11Y3A_	
			DPDT	PB78J22Y3B_	
			DPDT	PB78J11Y3C_	
			DPDT	PB78J22Y3D_	
			DPDT	PB78J11Y3E_	
			DPDT	PB78J22Y3G_	
			DPDT	PB78J22Y3H_	
			DPDT	PB78J22Y3H_	

Shape and Dimensions

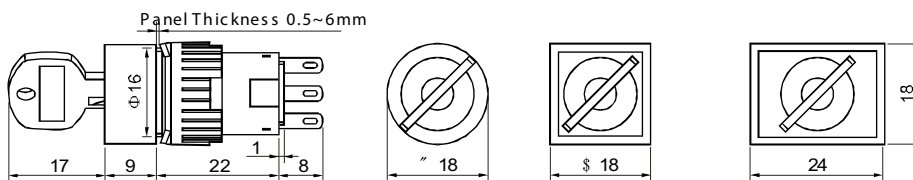

Pushbutton Switches

Pushbutton & Multifunction Switches IP40/IP65/IP67

PB78 Series

PB78 Emergency Pushbutton

Product Cutline

Shape	Contact	Type Number	Remarks
	SPDT	PB78Y11T_	Red and Green Protective Degree: IP 40, IP 65
	DPDT	PB78Y22T_	

Shape and Dimensions

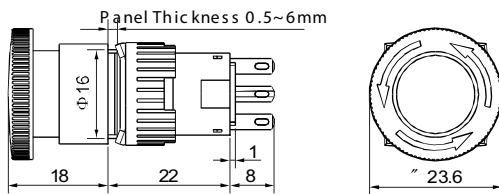

PB78 Buzzer Units

Specifications

Operating Temperature	- 25°C to 55°C
Operating Humidity	45- 85%RH
Dielectric Strength	1000V
Sound Duration	Continuous, Discontinuous
Rated Sound Pressure & Frequency	75 dB (1m)(Rated Voltage) 23004 300Hz
Operating Voltage	6VDC;12VDC;24VDC; 110VAC;220VAC

Shape and Dimensions

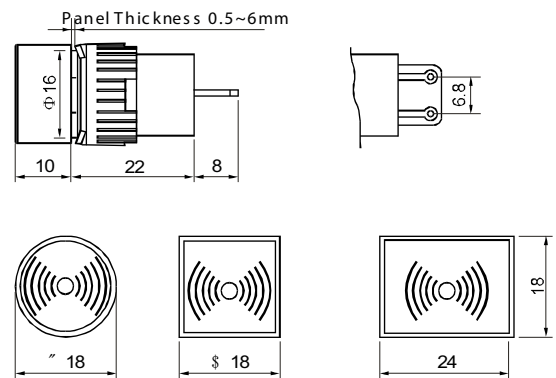

Product Cutline

Type Number	PB78YB_	PB78FB_	PB78JB_
Shape			