

# Pushbutton Switches

Anti-Vandal Pushbutton Switch - Mounting Hole Ø19mm

PAV19A Series



Terminal Type: Screw Terminal  
Front Shape: Domed

PAV19ANDW0N

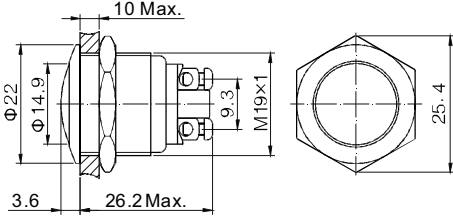

Terminal Type: Screw Terminal  
Front Shape: Flat Round

PAV19ANFW0N

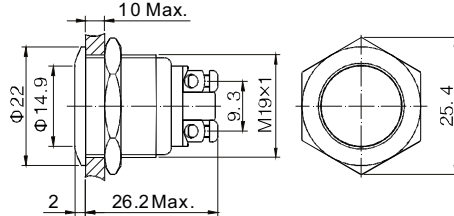

Terminal Type: Screw Terminal  
Front Shape: High Round

PAV19ANHW0N

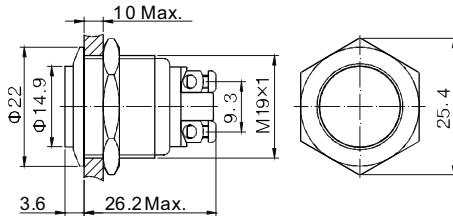

Terminal Type: Solder Lug 2.8x0.5mm  
Front Shape: Domed

PAV19ANDS0N

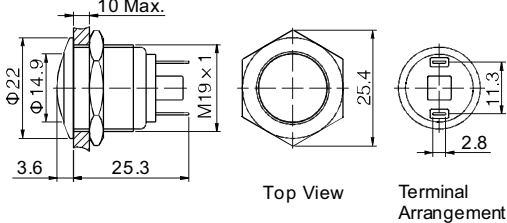

Terminal Type: Solder Lug 2.8x0.5mm  
Front Shape: Flat Round

PAV19ANFS0N

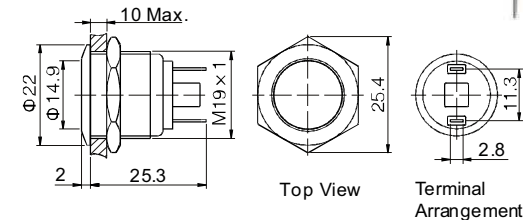

Terminal Type: Solder Lug 2.8x0.5mm  
Front Shape: High Round

PAV19ANHS0N

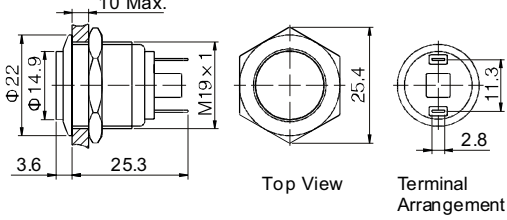

## How to order:

PAV19A 1 2 3 4 5 6 7

### 1 STRUCTURE:

No Code Standard Body  
S Short Body

### 2 SWITCHING CIRCUIT:

N 1NO (Standard)  
C 1NC (Made by request)

### 3 FRONT SHAPE:

D Domed  
F Flat Round  
H High Round  
PF Super Flat Head, Flat Button  
PH Super Flat Head, High Flat Button

### 4 TERMINATION:

W Screw Terminal  
S Solder Lug (2.8x0.5mm)

### 5 ILLUMINATION:

0 No Illumination

### 6 CRUST MATERIAL:

No Code Stainless Steel  
NK Nickel-plated Brass Crust  
AU Gold-plated Brass Crust  
BA Black anodized

### 7 ENGRAVING:

A Stop B Start  
C Return D Reset  
E | F ||  
G ◀ H ↑  
J ■ K ⏻  
L ⚡ M 🔔  
N ○



PAV19A\_DS0BAN  
black anodized

(Other engraving can be made by request)

## General Specifications:

### CHARACTERISTICS

- > Protection Degree: IP65
- > Anti Vandal Degree: IK09
- > Switch Rating: 2A 36VDC
- > Operation Type: Momentary
- > Contact Configuration: 1NO or 1NC
- > Contact Resistance: 50mohm Min.
- > Insulation Resistance: 1000Mohm Min.
- > Dielectric Intensity: 2000VAC
- > Operating Temperature: -20°C to +55°C
- > Mechanical Life: 1,000,000 cycles
- > Electrical Life: 200,000 cycles
- > Panel Thickness: 1 to 10 mm
- > Torque: 5 to 14 Nm
- > Operation Pressure: about 4 N
- > Operation Travel: about 1.8mm
- > Switching: Double-Break Slow-Motion Contact

### MATERIAL

- > Contact: Silver alloy
- > Button: Stainless steel / Brass (Nickel plated, Gold plated)
- > Body: Stainless steel / Brass (Nickel plated, Gold plated)
- > Base: PBT

# Pushbutton Switches

Anti-Vandal Pushbutton Switch - Mounting Hole  $\text{\O}19\text{mm}$

PAV19A Series



Terminal Type: Screw Terminal  
Front Shape: Super Flat  
Illumination: Non Illuminated

PAV19ANPFW0NN

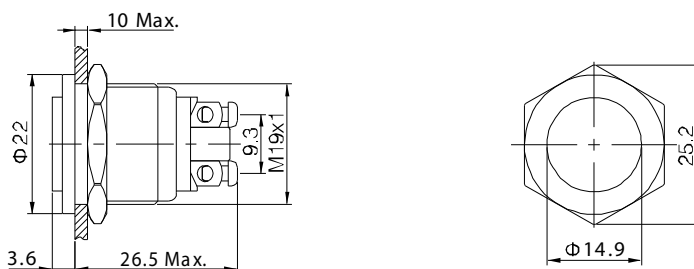

Terminal Type: Solder Lug  
Front Shape: Super Flat High  
Illumination: Non Illuminated

PAV19ANPHS0NN

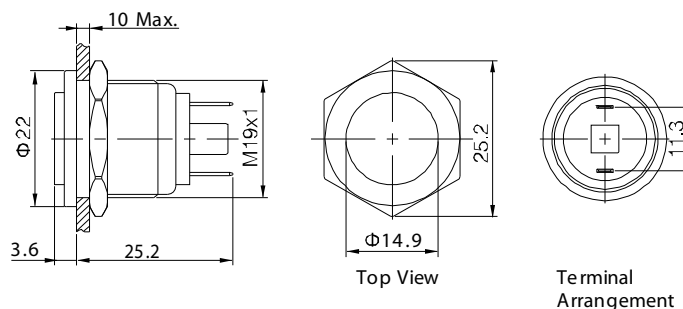

Body Type: Short Body  
Terminal Type: Solder Lug  
Front Shape: Super Flat  
Illumination: Dot Illuminated

PAV19ASNPFW0N

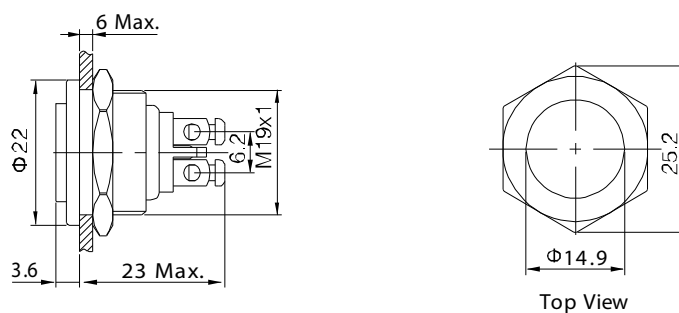

Body Type: Short Body  
Terminal Type: Solder Lug  
Front Shape: Super Flat High  
Illumination: Dot Illuminated

PAV19ASNPHW0N

