

Rocker Switches

Sealed Miniature Rocker & Paddle Switches

RK14 Series

UL version available by request

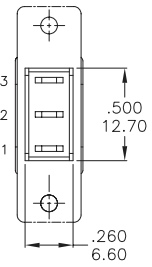
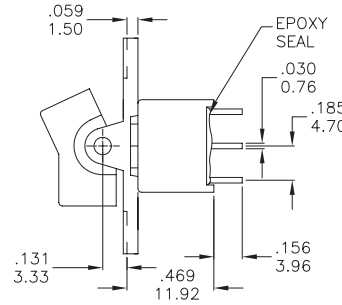
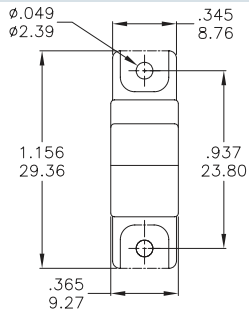

RK14S1A1NANT1AUEV

UL version available by request

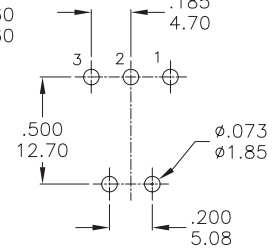
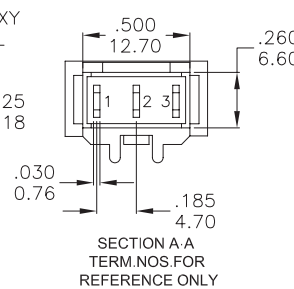
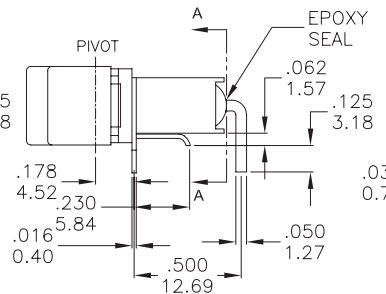
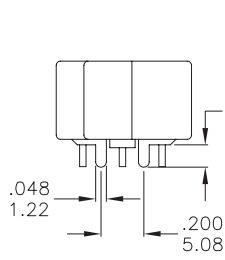

RK14S1J1NANT6AUEV

UL version available by request

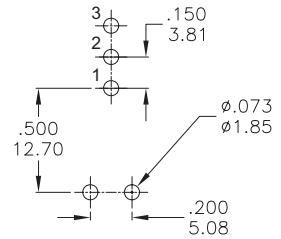
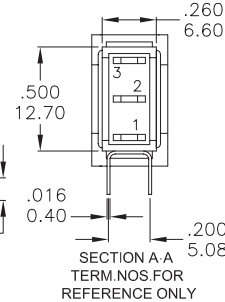
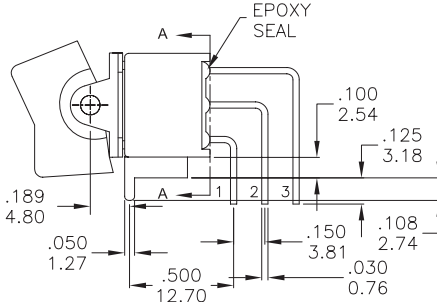
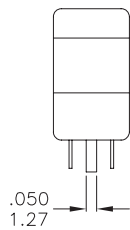
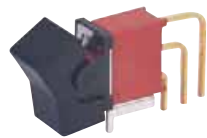

RK14S1J1NANT7AUEV

UL version available by request

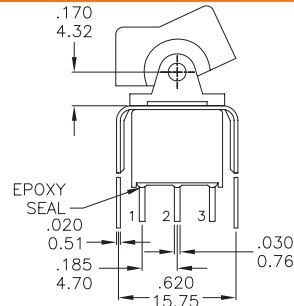
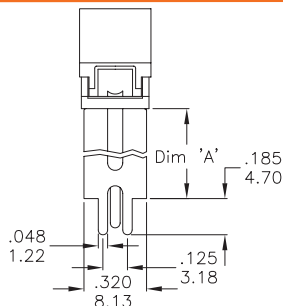

OPTION CODE	DIM. 'A'
VS2	.460 11.68
VS3	.630 16.00

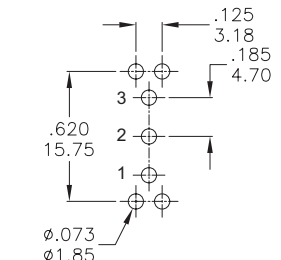

RK14S1J1NANVS2AUEV

How to order:

RK14

1 POLES & SWITCH FUNCTION:

- S1 SP ON-NONE-ON
- S2 SP ON- NONE-MOM
- S3 SP ON-OFF-ON
- S4 SP MOM-OFF-MOM
- S5 SP ON-OFF-MOM
- D1 DP ON-NONE-ON
- D2 DP ON-NONE-MOM
- D3 DP ON-OFF-ON
- D4 DP MOM-OFF-MOM
- D5 DP ON-OFF-MOM
- D6 DP ON-ON-ON
- D7 DP MOM-ON-MOM
- D8 DP ON-MOM
- T1 3P ON-NONE-ON
- T2 3P ON-NONE-MOM
- T3 3P ON-OFF-ON
- T4 3P MOM-OFF-MOM
- T5 3P ON-OFF-MOM

P.C.MOUNT Only

- J1 13.49 Long Rocker
- J2 Lever
- J3 23.01 Long Rocker
- J4 Lever
- J5 9.19 Long Rocker
- J6 Lever
- J7 Lever
- J8 Lever

5 ACTUATOR MARKING

- | | | |
|---|---|---|
| A | D | G |
| B | E | H |
| C | F | N |

4 + 5 ACTUATOR & FRAME COLOR

- | | |
|---------------|-----------|
| A Black(Std.) | B White |
| E Yellow | C Red |
| G Blue | F Green |
| H Grey | K Brown |
| D Orange | N Without |

6 TERMINALS:

- T1 Solder Lug
- T2 PC Thru-hole
- T3 Quick Connect
- T51 18.70 High, Wire Wrap
- T52 24.20 High, Wire Wrap
- T53 10.50 High, Wire Wrap
- T54 26.97 High, Wire Wrap
- T6 Right Angle, PC Thru-hole
- T6N Right Angle, Snap-in PC Thru-hole
- T7 Vertical Right Angle, PC Thru-hole
- VS2 11.68 High, V-bracket
- V2N 11.68 High, Snap-in, V-bracket
- VS3 16.00 High, V-bracket

7 CONTACT MATERIAL:

- AG Silver
- AU Gold
- UT Gold, Tin-lead
- GT Silver, Tin-lead
- UG Gold over Silver
- UGT Gold over Silver, Tin-lead

8 SEAL:

- E Epoxy (Standard)
- N No Epoxy

9 ROHS & LEAD FREE:

- blank RoHS compliant
- V RoHS & lead free

General Specifications:

MATERIALS

- » Movable Contact & Fixed Terminals:
 - AG, GT, UG & UGT: Silver plated over copper alloy
 - AU & UT: Gold over nickel plated over copper alloy
- » Actuator: Nylon
- » Bushing: Brass, nickel plated
- » Housing: Stainless Steel
- » Switch Support: Brass, tin plated.

MECHANICAL

- » Operating Temperature: -30°C to +85°C
- » Mechanical Life: 30,000 cycles

CONTACT RATING

- » AG, GT, UG & UGT: 5A 120VAC/28VDC
2A 250VAC
- » AU & UT: 0.4 VA max. 20V max. (AC/DC)

ELECTRICAL

- » Contact Resistance: 10m Ω max. initial @ 2-4VDC for both silver & gold plated contacts
- » Insulation Resistance: 1,000M Ω min
- » Dielectric Strength: 1,000V RMS@sea level

All specifications are restricted to QA test criteria.
DRW: D.L. JIN, CHK: D.F. LEE, APP: H.Z. QIU

Rocker Switches

Sealed Miniature Rocker & Paddle Switches

RK14 Series



UL version available by request



RK14D1A1NANT1AUEV

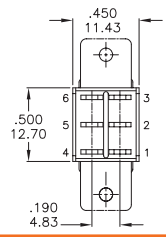
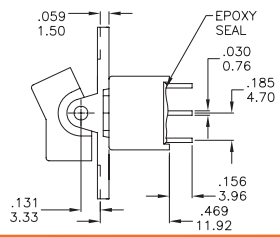
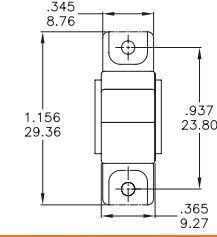

UL version available by request



RK14T1A1NANT1AUEV

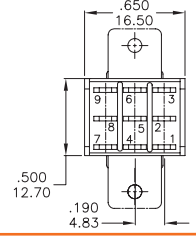
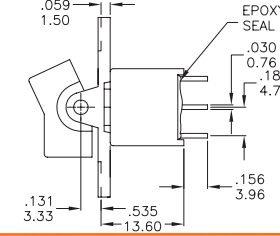
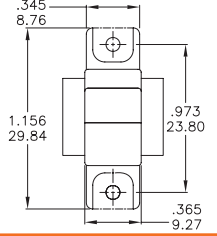

UL version available by request



RK14D1J1NANT6AUEV

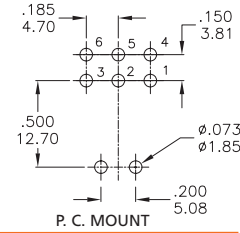
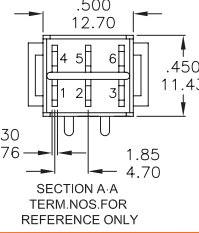
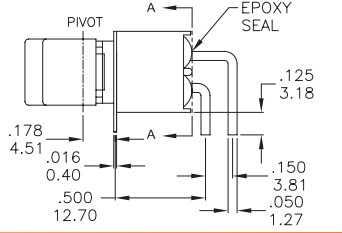
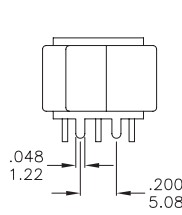

UL version available by request



RK14T1J1NANT6AUEV

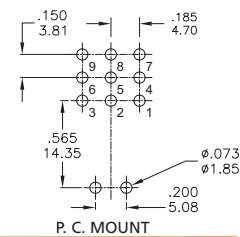
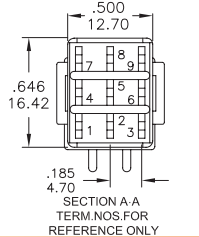
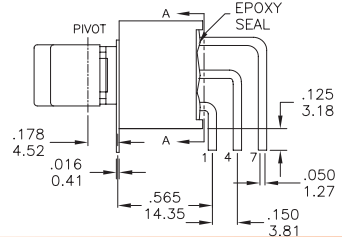
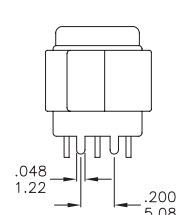

UL version available by request



RK14D1J1NANT7AUEV

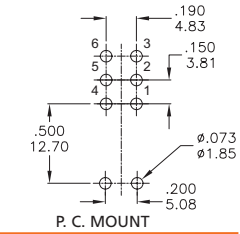
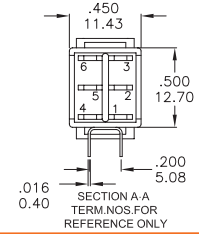
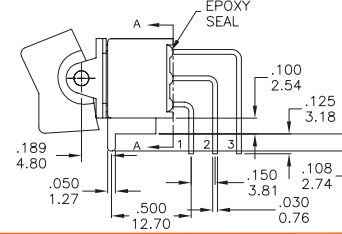
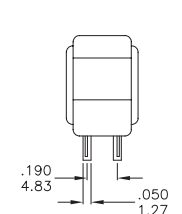

UL version available by request



RK14T1J1NANT7AUEV

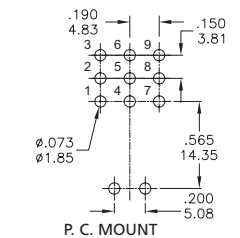
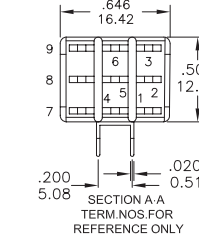
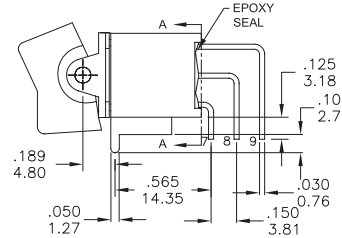
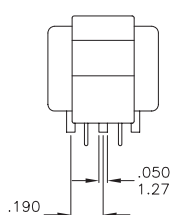

UL version available by request



RK14D1J1NANVS2AUEV

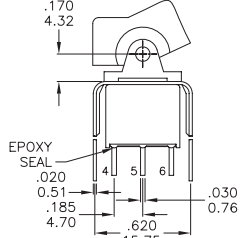
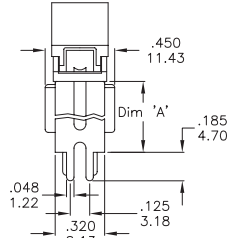

OPTION CODE	DIM. 'A'
VS2	.460 (11.68)
VS3	.630 (16.00)

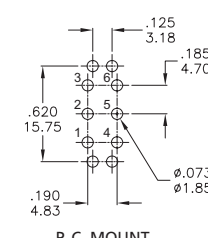

UL version available by request



RK14T1J1NANVS2AUEV

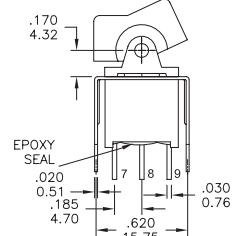
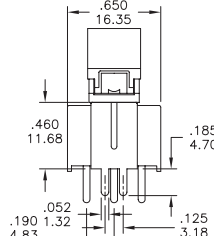

OPTION CODE	DIM. 'A'
VS2	.460 (11.68)
VS3	.630 (16.00)

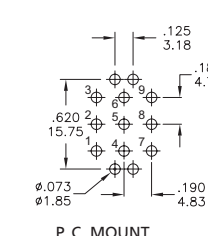

Rocker Switches

Sealed Miniature Rocker & Paddle Switches

RK14 Series

SWITCH FUNCTION

NO. POLES	MODEL NO.	SWITCH FUNCTION			CONNECTED TERMINALS / SCHEMATIC		
		POS.1	POS.2	POS.3	POS.1	POS.2	POS.3
SP	S1	ON	NONE	ON		N/A	
	S2	ON	NONE	MOM	2-3		2-1
	S3	ON	OFF	ON			
	S4	MOM	OFF	MOM	2<COMM>	OPEN	2<COMM>
	S5	ON	OFF	MOM			
DP	D1	ON	NONE	ON		N/A	
	D2	ON	NONE	MOM	2-3,5-6		2-1,5-4
	D3	ON	OFF	ON			
	D4	MOM	OFF	MOM	2<COMM>	OPEN	2<COMM>
	D5	ON	OFF	MOM			
	D6	ON	ON	ON			
	D7	MOM	ON	MOM	2-3,5-6	2-3,5-4	2-1,5-4
	D8	ON	ON	MOM			
3P	T1	ON	NONE	ON		N/A	
	T2	ON	NONE	MOM	2-3,5-6,8-9		2-1,5-4,8-7
	T3	ON	OFF	ON			
	T4	MOM	OFF	MOM	2<COMM>	OPEN	2<COMM>
	T5	ON	OFF	MOM			

MOM=MOMENTARY

▲ Please check the availability in advance before order

TERMINATION OPTIONS

T1 SOLDER LUG

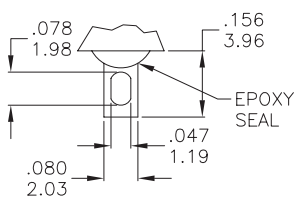

THK .030(0.76)

T2 PC THRU - HOLE

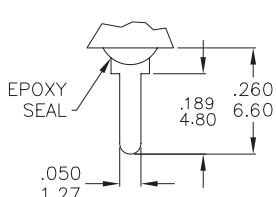

THK .030(0.76)

T3 QUICK CONNECT

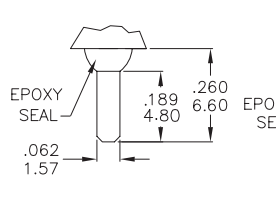

THK .030(0.76)

T5 WIRE WRAP

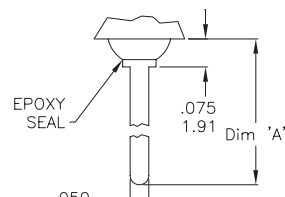

THK .030(0.76)

OPTION CODE	DIM. 'A'
T51	.737(18.70)
T52	.953(24.20)
T53	.415(10.55)
T54	1.062(26.97)

SNAP - IN TERMINATION OPTIONS

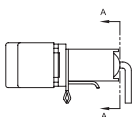

T6N

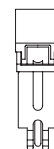

V2N

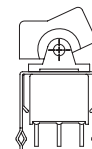

Rocker Switches

Sealed Miniature Rocker & Paddle Switches

RK14 Series

ACTUATOR OPTIONS FOR PANEL MOUNT ONLY

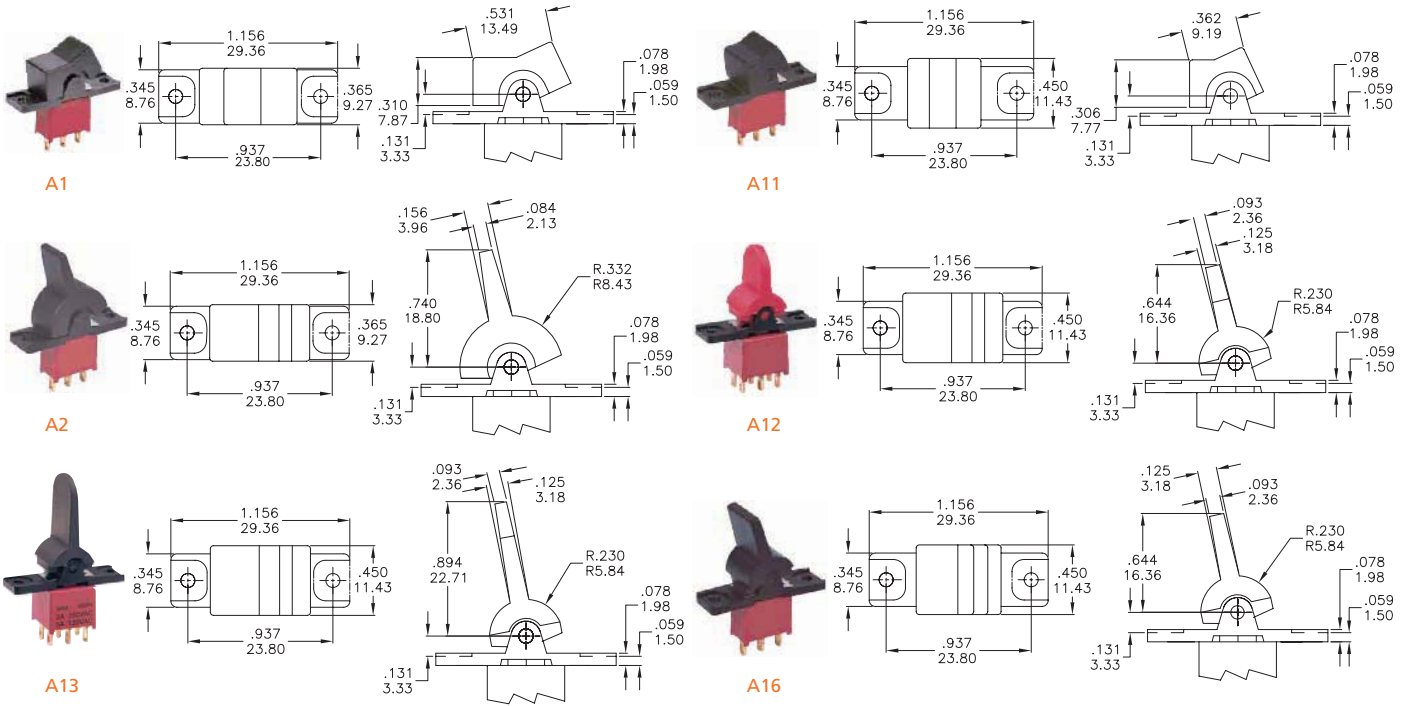

ACTUATOR OPTIONS FOR P. C. MOUNT ONLY

